

**Adolfo Camarillo
 High School
 Aquatic Center**
 4660 Mission Oaks Boulevard
 Camarillo, California 93012

 **Oxnard Union
 High School
 District**
 309 South K Street
 Oxnard, California 93030

IDENTIFICATION STAMP
 DIV. OF THE STATE ARCHITECT
 OFFICE OF REGULATION SERVICES
 APPL #XXXXXXXX
 DATE _____
 P.T.N.: 72546-54

© 2011 Blackbird Architects Inc.
 The design ideas and plans represented by these documents are the property of Blackbird Architects. Use or copy is permitted by contract only. The use or revisions of these ideas or plans is prohibited without the written permission of Blackbird Architects.

**NOT FOR
 CONSTRUCTION**

Master Site Plan

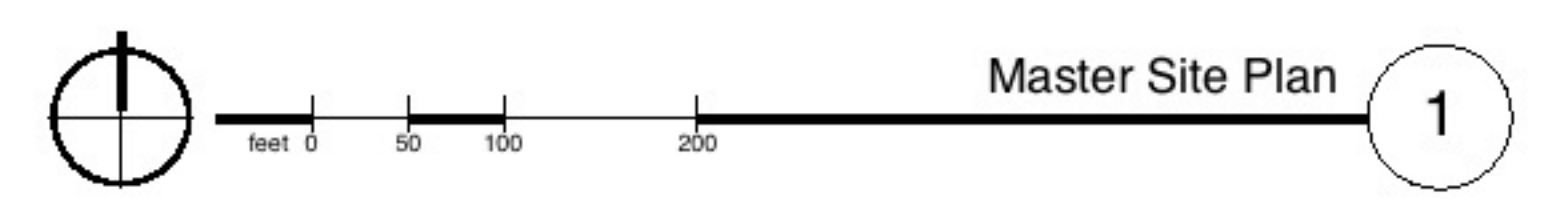

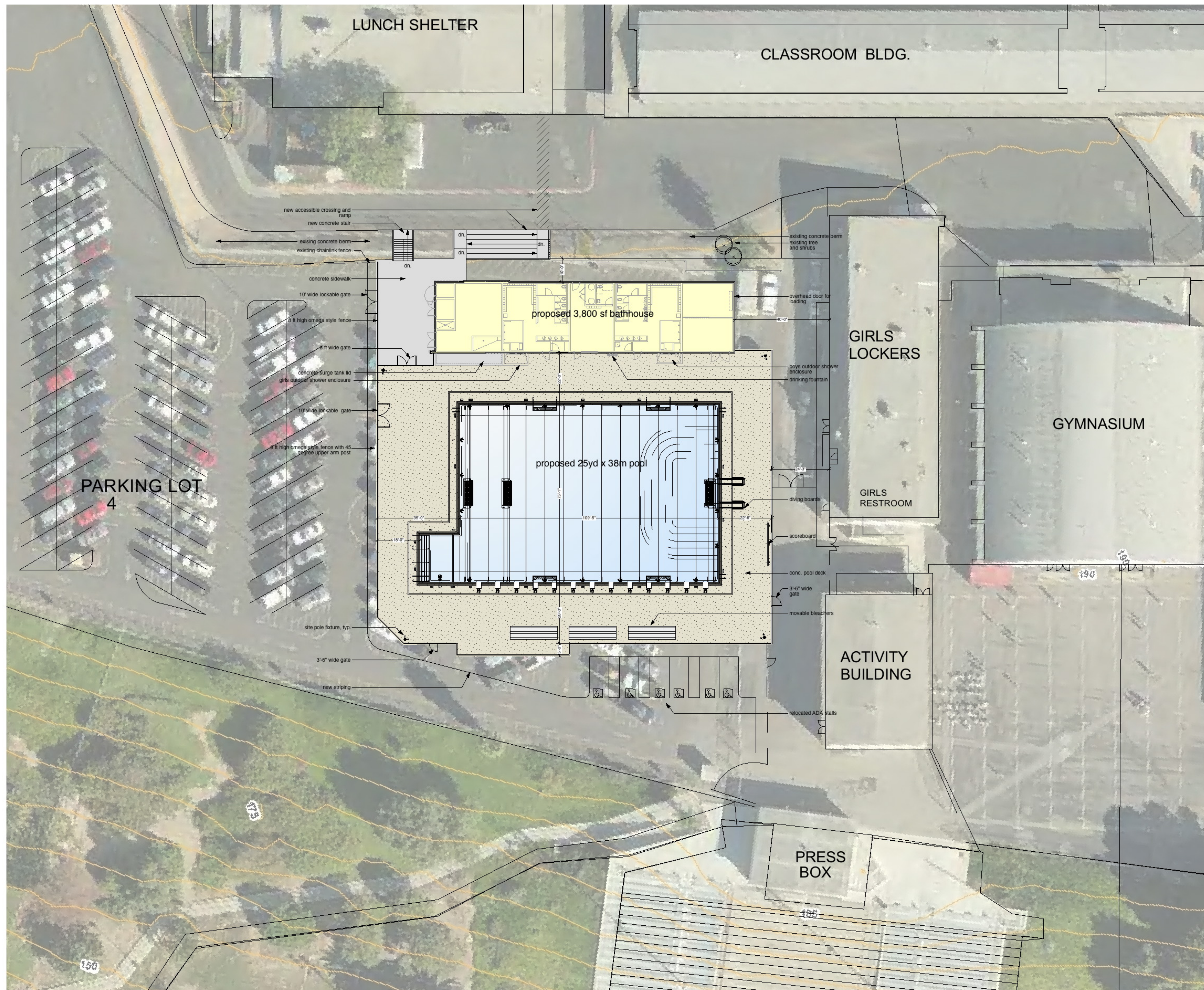

Adolfo Camarillo High School Aquatic Center
 4660 Mission Oaks Boulevard
 Camarillo, California 93012



Oxnard Union High School District
 309 South K Street
 Oxnard, California 93030

IDENTIFICATION STAMP
 DIV. OF THE STATE ARCHITECT
 OFFICE OF REGULATION SERVICES
 APPL #XXXXXXXX
 DATE _____
 P.T.N.: 72546-54

© 2011 Blackbird Architects Inc.
 The design ideas and plans represented by these documents are the property of Blackbird Architects. Use or copy is permitted by contract only. The use or revisions of these ideas or plans is prohibited without the written permission of Blackbird Architects.

NOT FOR CONSTRUCTION

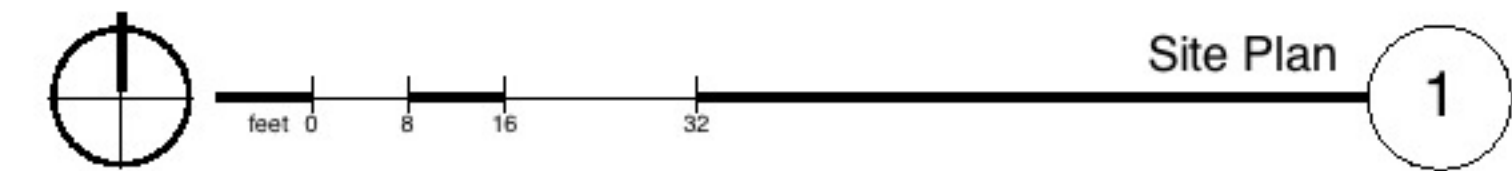
Site Plan



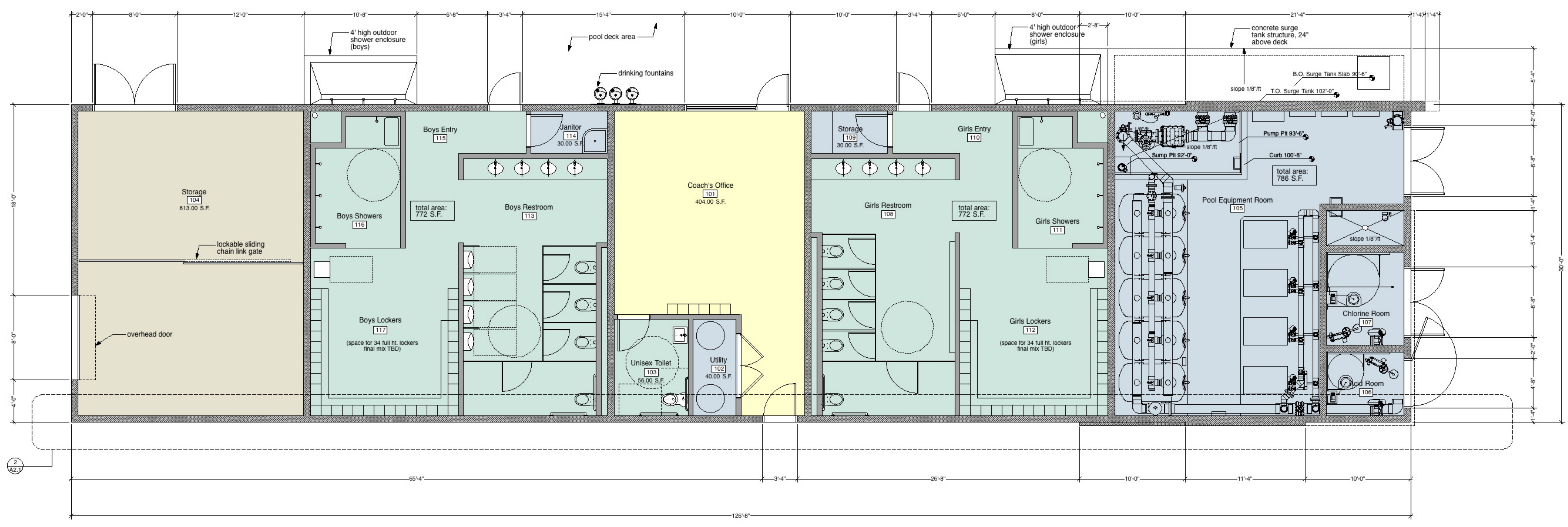

First Floor Plan 1

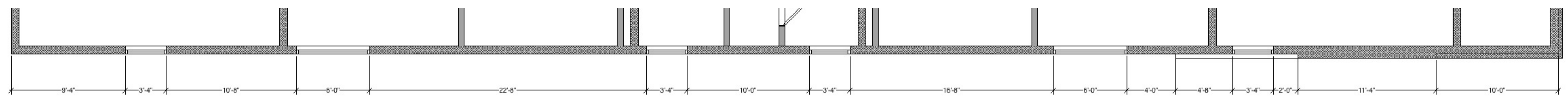

Clearstory Plan 2

Adolfo Camarillo High School Aquatic Center
 4660 Mission Oaks Boulevard
 Camarillo, California 93012

Oxnard Union High School District
 309 South K Street
 Oxnard, California 93030

IDENTIFICATION STAMP
 DIV. OF THE STATE ARCHITECT
 OFFICE OF REGULATION SERVICES
 APPL #XXXXXXXX
 DATE _____
 P.T.N.: 72546-54

© 2011 Blackbird Architects Inc.
 The design ideas and plans represented by these documents are the property of Blackbird Architects. Use or copy is permitted by contract only. The use or revisions of these ideas or plans is prohibited without the written permission of Blackbird Architects.

NOT FOR CONSTRUCTION

Plans
 First Floor Plan
 Clearstory Plan

Keynotes

- ① Precision face CMU, color 1
- ② Precision face CMU, color 2
- ③ Split-face CMU, color 1
- ④ Split-face CMU, color 2
- ⑤ Glazed CMU, color 1
- ⑥ Glazed CMU, color 2
- ⑦ Hollow metal door and frame, painted
- ⑧ Clear anodized storefront system with insulated glazing
- ⑨ Louvers
- ⑩ Drinking fountain
- ⑪ Pre-finished metal roof edge flashing
- ⑫ Pre-finished metal liner panel
- ⑬ Pre-finished parapet cap flashing
- ⑭ Skylights, color to match roof
- ⑮ Shower head
- ⑯ Line of 4' high shower enclosure wall in foreground
- ⑰ Cast-in-place concrete with smooth rubbed finish
- ⑱ Scoreboard
- ⑲ 8' high omega style fence with 45 degree top post
- ⑳ 8' high omega style fence
- ㉑ Metal gate
- ㉒ Existing building to remain
- ㉓ Pre-finished metal coiling overhead door

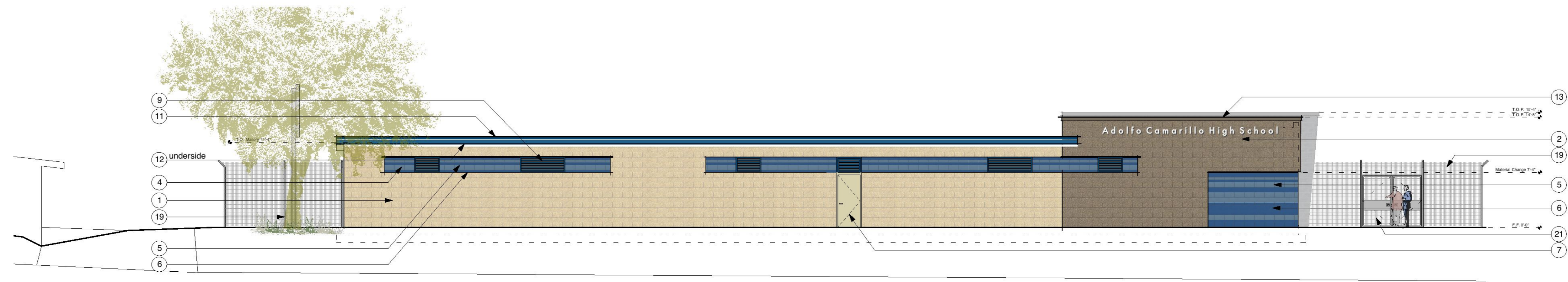

North Elevation 1



South Elevation 2

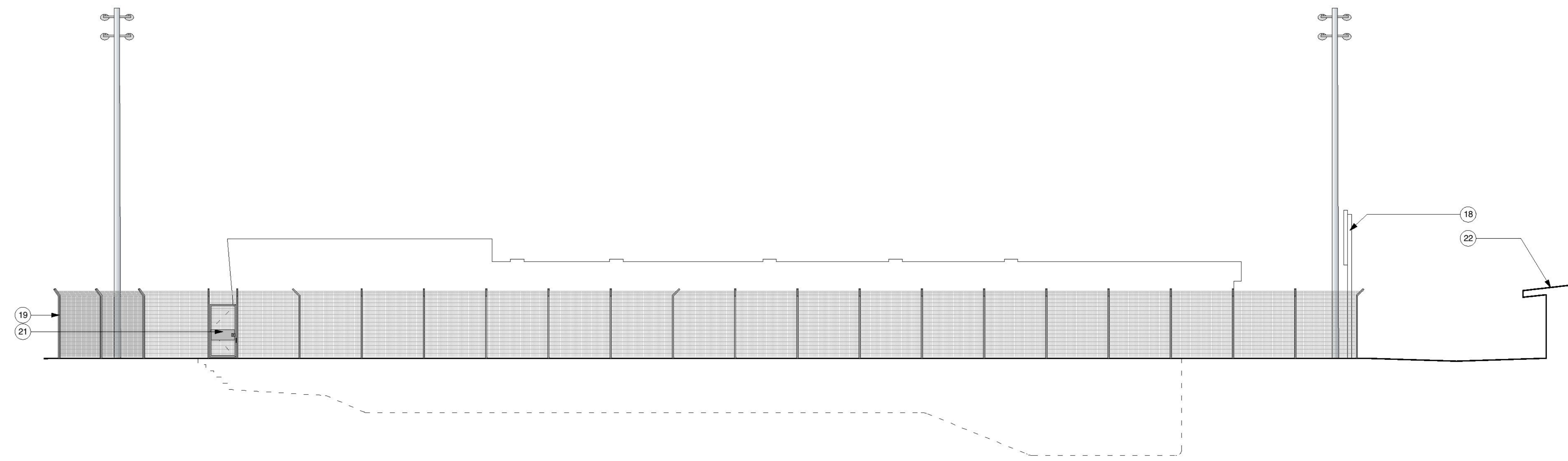

South Elevation 2

Adolfo Camarillo High School Aquatic Center
 4660 Mission Oaks Boulevard
 Camarillo, California 93012

Oxnard Union High School District
 309 South K Street
 Oxnard, California 93030

IDENTIFICATION STAMP
 DIV. OF THE STATE ARCHITECTS
 OFFICE OF REGULATION SERVICES
 APPL #XXXXXXX
 AC _____ FL _____ SS _____
 DATE _____
 P.T.N.: 72546-54

© 2011 Blackbird Architects Inc.
 The design ideas and plans represented by these documents are the property of Blackbird Architects. Use or copy is permitted by contract only. The use or revisions of these ideas or plans is prohibited without the written permission of Blackbird Architects.

NOT FOR CONSTRUCTION

Building Elevations

Keynotes

- ① Precision face CMU, color 1
- ② Precision face CMU, color 2
- ③ Split-face CMU, color 1
- ④ Split-face CMU, color 2
- ⑤ Glazed CMU, color 1
- ⑥ Glazed CMU, color 2
- ⑦ Hollow metal door and frame, painted
- ⑧ Clear anodized storefront system with insulated glazing
- ⑨ Louvers
- ⑩ Drinking fountain
- ⑪ Pre-finished metal roof edge flashing
- ⑫ Prefinished metal liner panel
- ⑬ Pre-finished parapet cap flashing
- ⑭ Skylights, color to match roof
- ⑮ Shower head
- ⑯ Line of 4' high shower enclosure wall in foreground
- ⑰ Cast-in-place concrete with smooth rubbed finish
- ⑱ Scoreboard
- ⑲ 8' high omega style fence with 45 degree top post
- ⑳ 8' high omega style fence
- ㉑ Metal gate
- ㉒ Existing building to remain
- ㉓ Pre-finished metal coiling overhead door

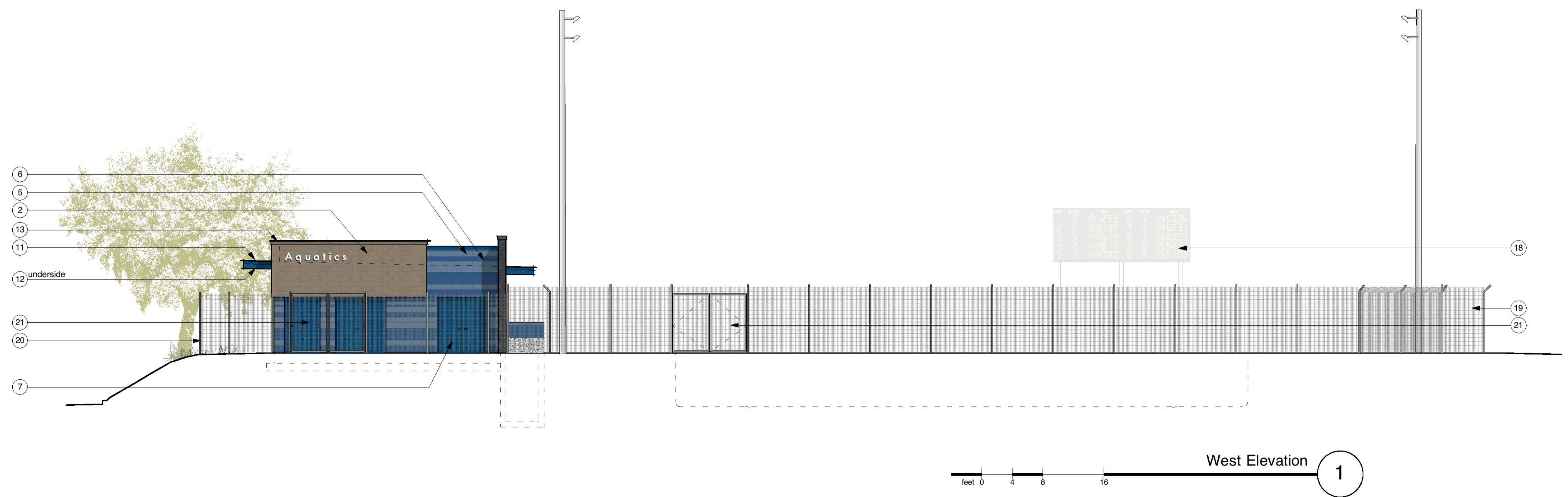
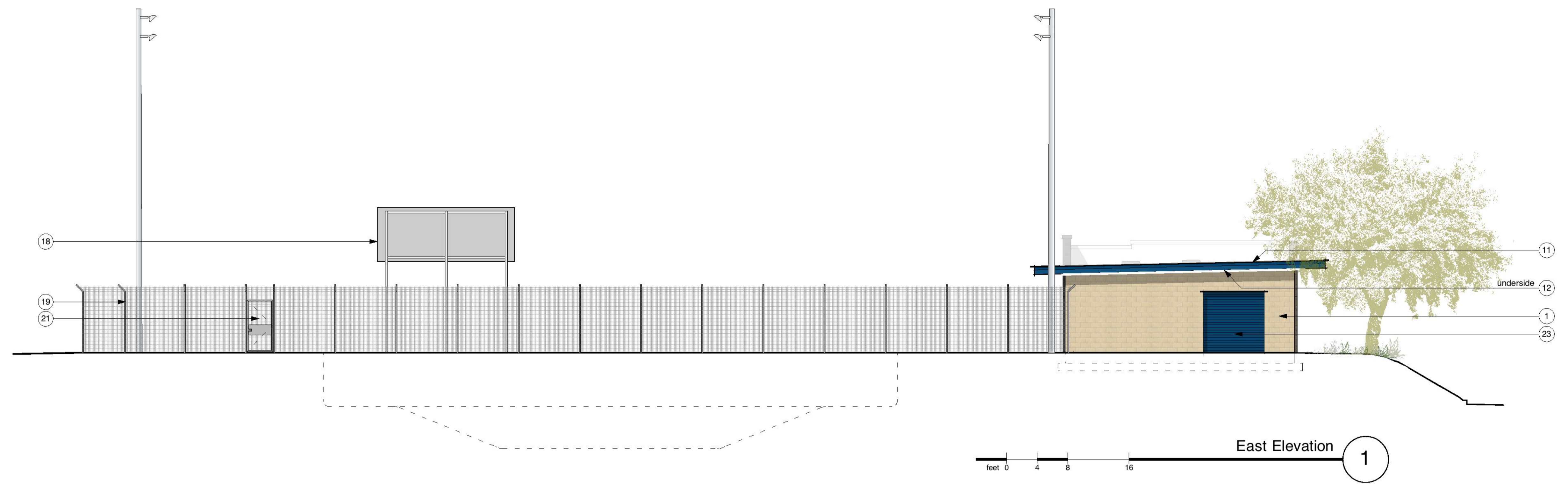

Adolfo Camarillo High School Aquatic Center
 4660 Mission Oaks Boulevard
 Camarillo, California 93012

Oxnard Union High School District
 309 South K Street
 Oxnard, California 93030

IDENTIFICATION STAMP
 DIV. OF THE STATE ARCHITECT
 OFFICE OF REGULATION SERVICES
 APPL #XXXXXXX
 AC _____ FL _____ SS _____
 DATE _____
 P.T.N.: 72546-54

© 2011 Blackbird Architects Inc.
 The design ideas and plans represented by these documents are the property of Blackbird Architects. Use or copy is permitted by contract only. The use or revisions of these ideas or plans is prohibited without the written permission of Blackbird Architects.

NOT FOR CONSTRUCTION

Building Elevations



1 View from West



2 Aerial View from NE



3 Perspective from NE



4 Perspective from NW



5 Perspective at the Bathhouse

**Adolfo Camarillo
High School
Aquatic Center**

500 West Bard Road
Oxnard, California 93053



**Oxnard Union
High School
District**

309 South K Street
Oxnard, California 93030

© 2011 Blackbird Architects, Inc.
The design ideas and plans represented by these documents are the property of Blackbird Architects, Inc. Use or copy is permitted by contract only. The use or revisions of these ideas or plans is prohibited without the written permission of Blackbird Architects, Inc.

Perspective Views